

Materiaal

2x Multiplex plaat 6mm dik, 60x122 cm.

1x Vuren lat 35x19mm, lengte 650mm.

Schroeven 3x20mm, 14 stuks.

Spijkers 3x70mm 2 stuks.

Houtlijm. Plamuur. Verf, wit.

Material

2x Plywood 6mm , 60x122 cm.

1x 35x19mm, L= 650mm.

Screw 3x20mm, 14 x.

Nails 3x70mm 2 x.

Glue, priming, white paint.

Material

2x Sperrholz 6mm, 60x122 cm.

1x 35x19mm, L= 650mm.

Schrauben 3x20mm, 14 x.

Nägel 3x70mm 2 x.

Holzleim Grundiermasse, Farbe weiß.

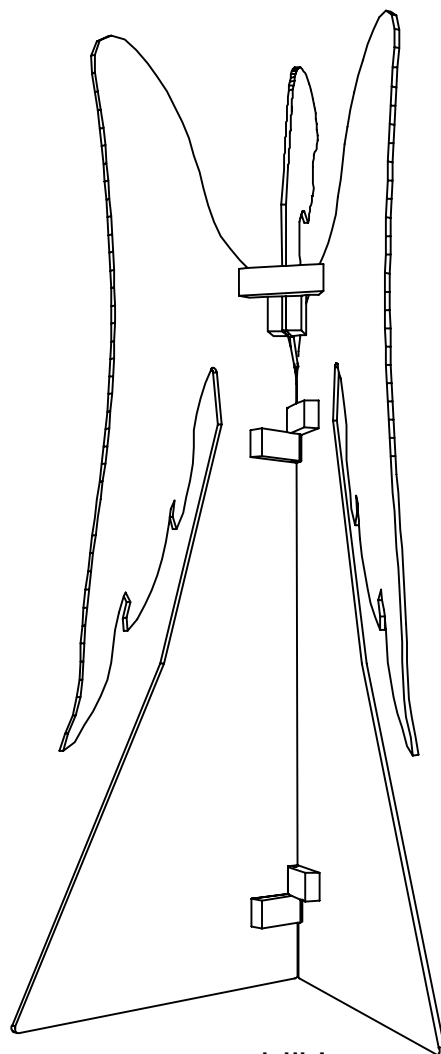

pre-drill !



"ENGEL"

Size. ± 117x48x40 cm

© L.Lammertsma

#040



PLANS
sjablonen

ONZE PATRONEN SAMENSTELLEN ZUSEMMENSTELLEN UNSERER SCHNITTMUSTER ASSEMBLING OUR PATTERNS

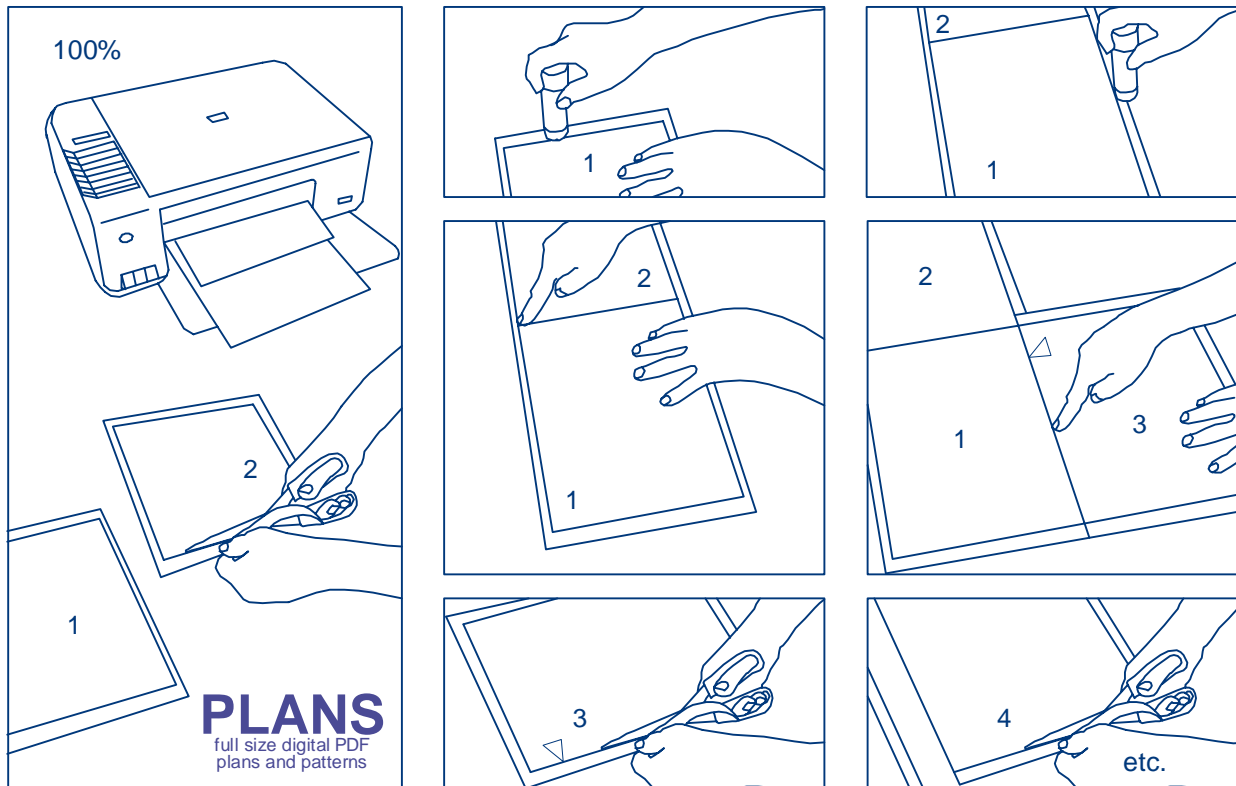

Het patroon monteren door de delen: *Afdrukken op eigen printer op A4 100%. *De linker en bovenrand volgens stippellijn afknippen.

*De rechterraand van nummer 1 met lijmstift insmeren en onder nummer 2 plakken tot de stippellijn. enz

Montieren Sie das Muster durch die Teile: *Druck auf eigenem Drucker auf A4 100%. *Schneiden Sie die linke und obere Kante gemäß der gepunkteten Linie. *Die rechte Kante von Nummer 1 mit einem Klebestift bestreichen und auf Nummer 2 kleben. etc.

Assemble the pattern through the parts: *printing on own printer on A4 100%. *cut the left and top edge according to the dotted line.

Coat the right edge of number 1 with a glue stick and stick to number 2. etc.

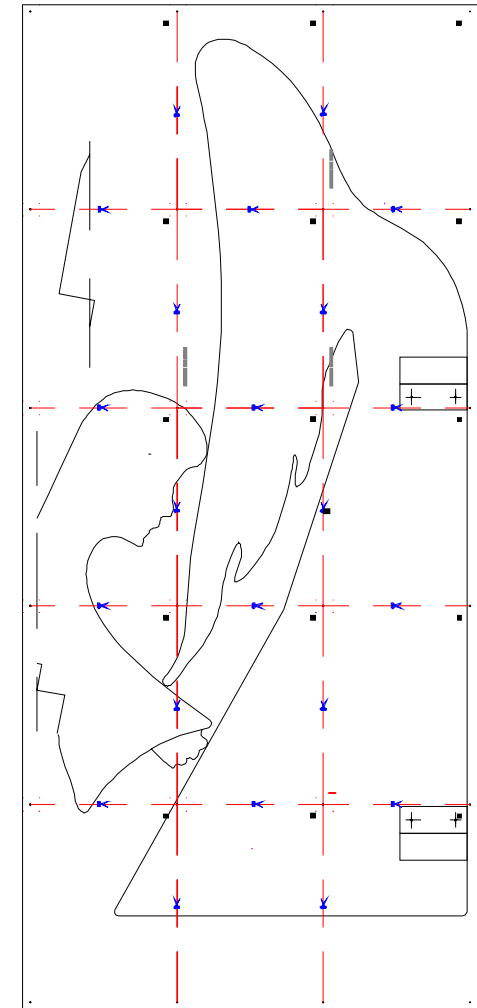

UITKNIPPEN EN OMTREK AFTEKENEN.
CUT OUT AND DRAW OUTLINE.
AUSSCHNEIDEN UND UMRISSE ZEICHNEN.

01

PLANS
for makers

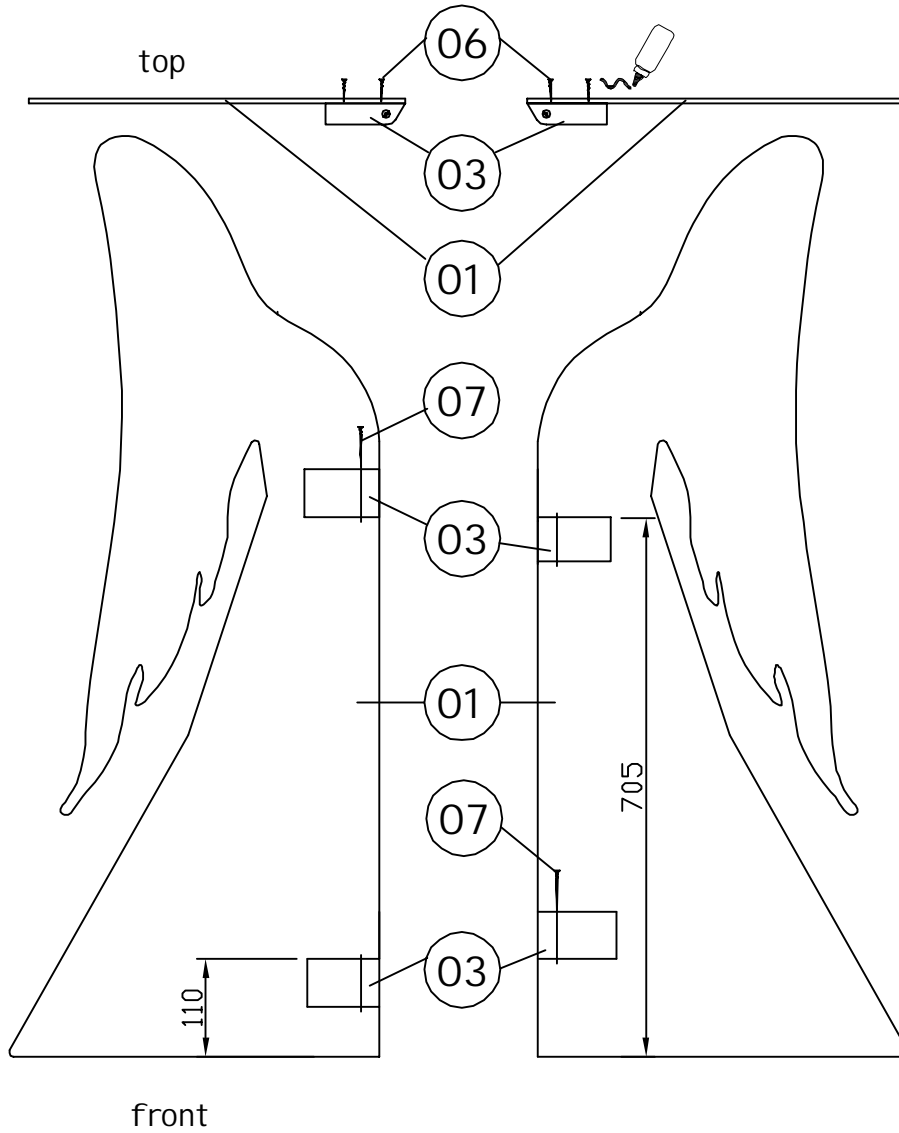

"ENGEL"

Size. ± 117x48x40 cm

© L.Lammertsma

#040

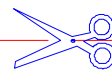
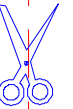
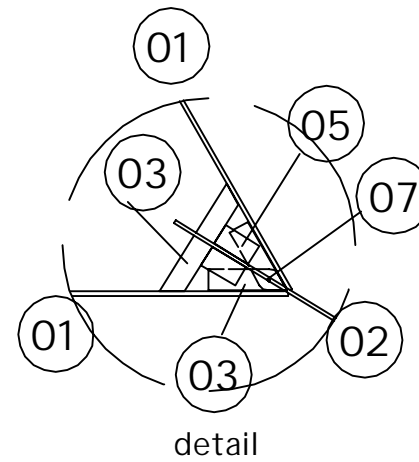
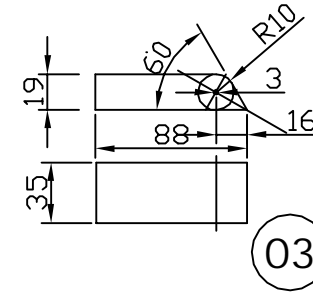

02

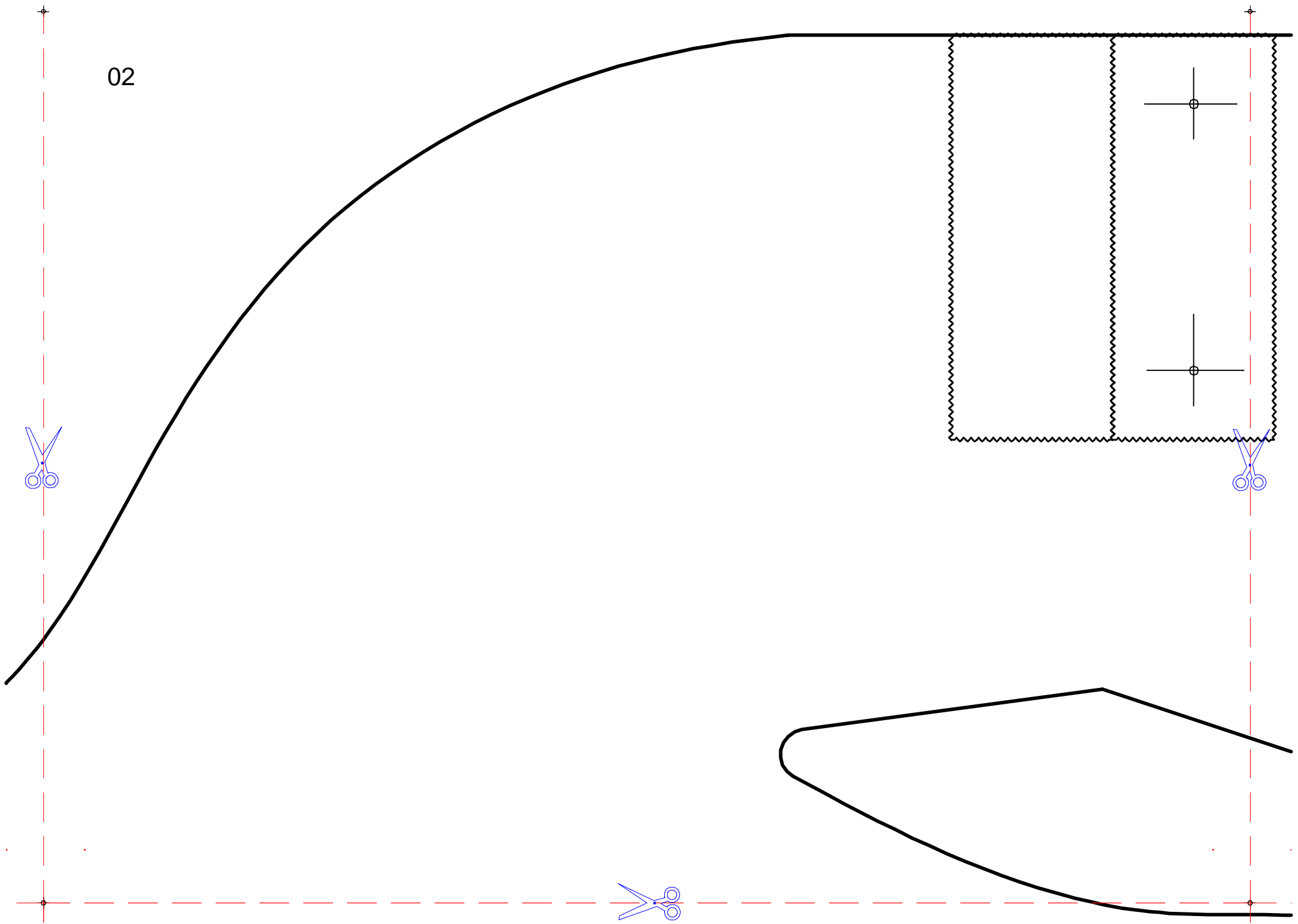

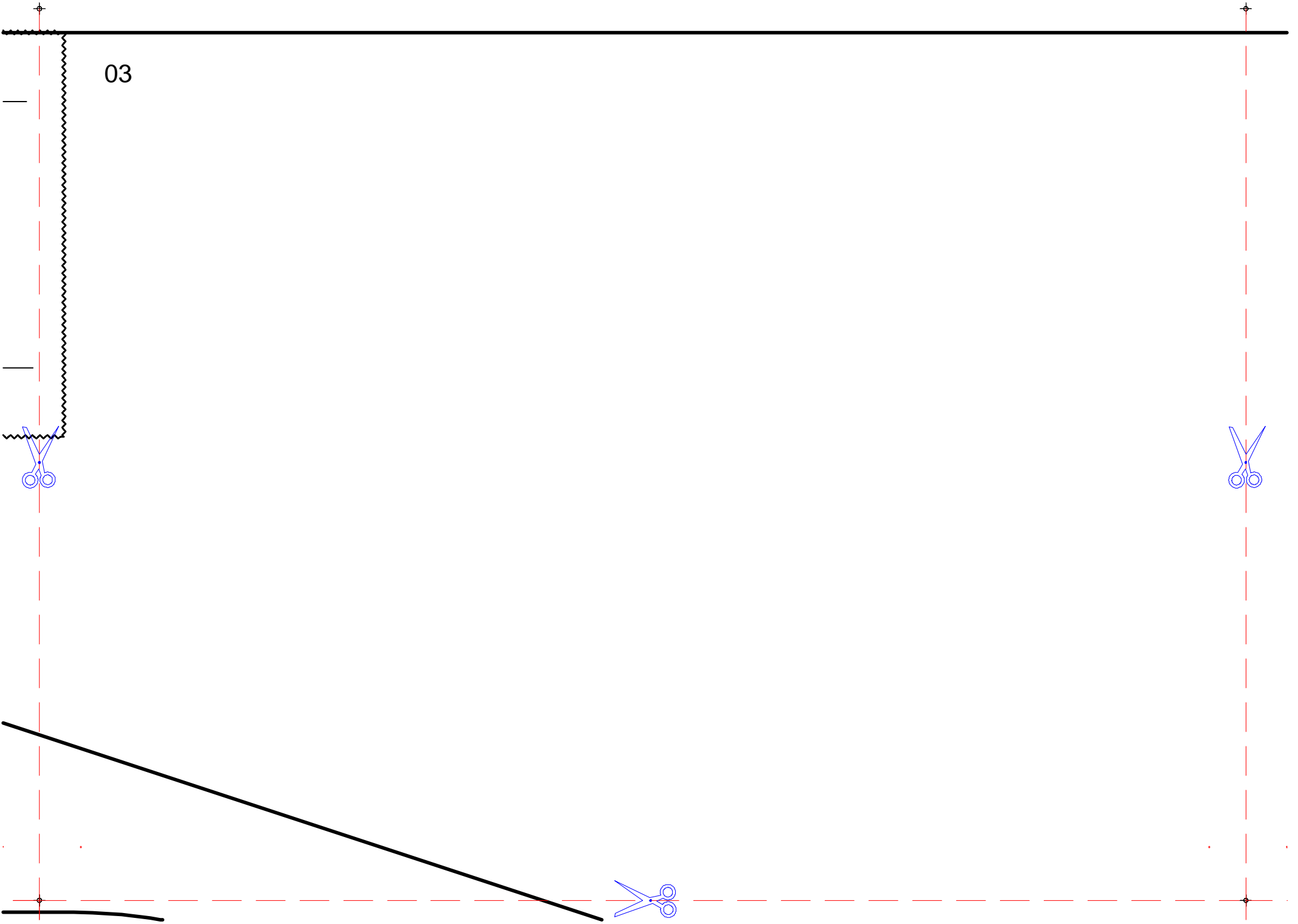

04

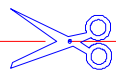
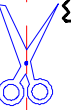
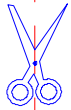

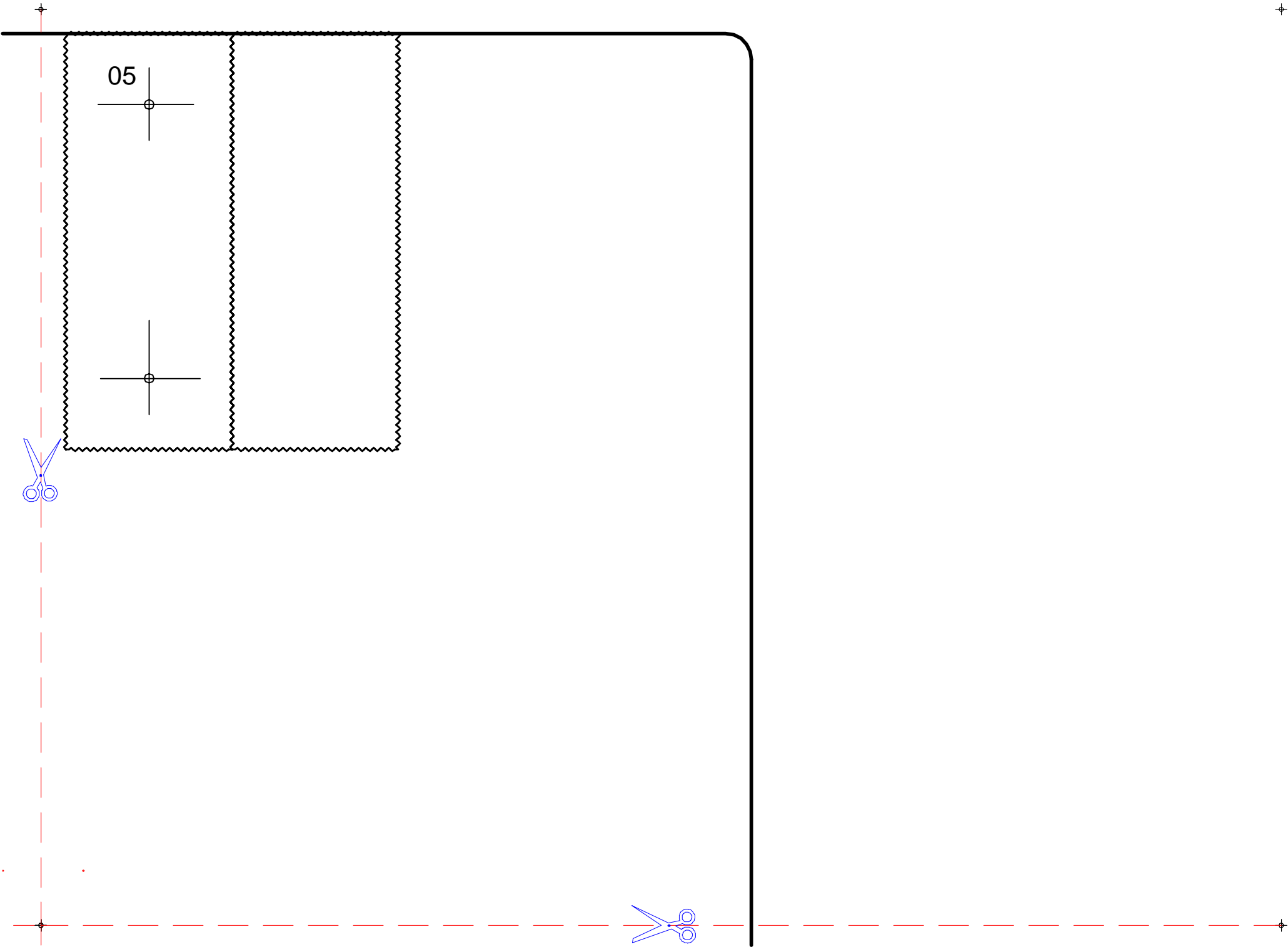

05

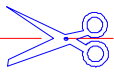
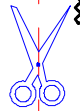

06

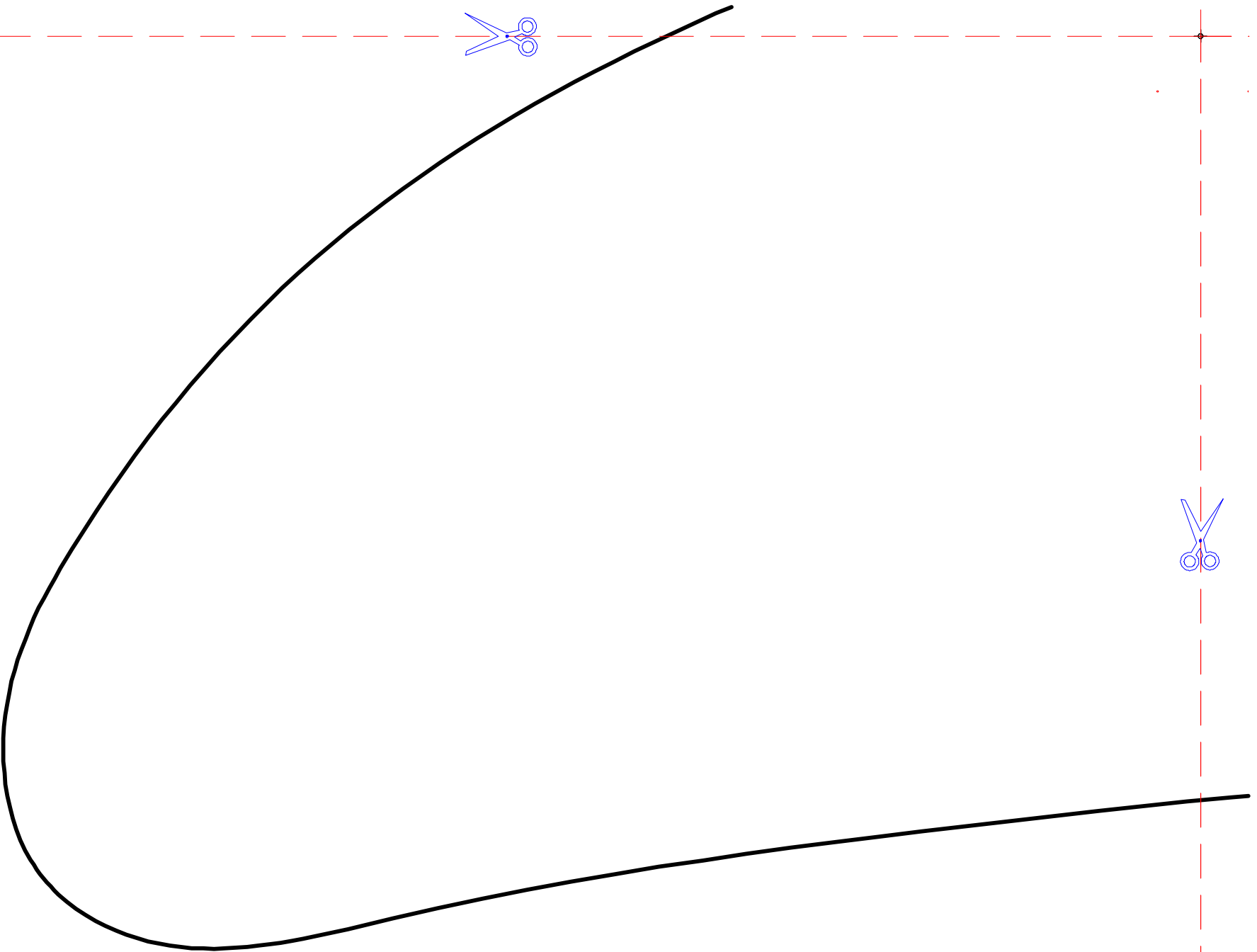
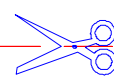
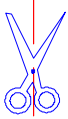
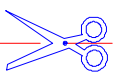

07

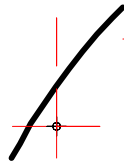
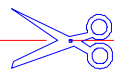
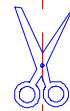
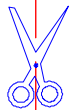
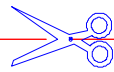

08

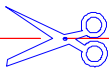
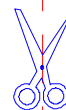
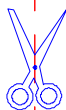
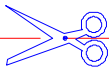

09

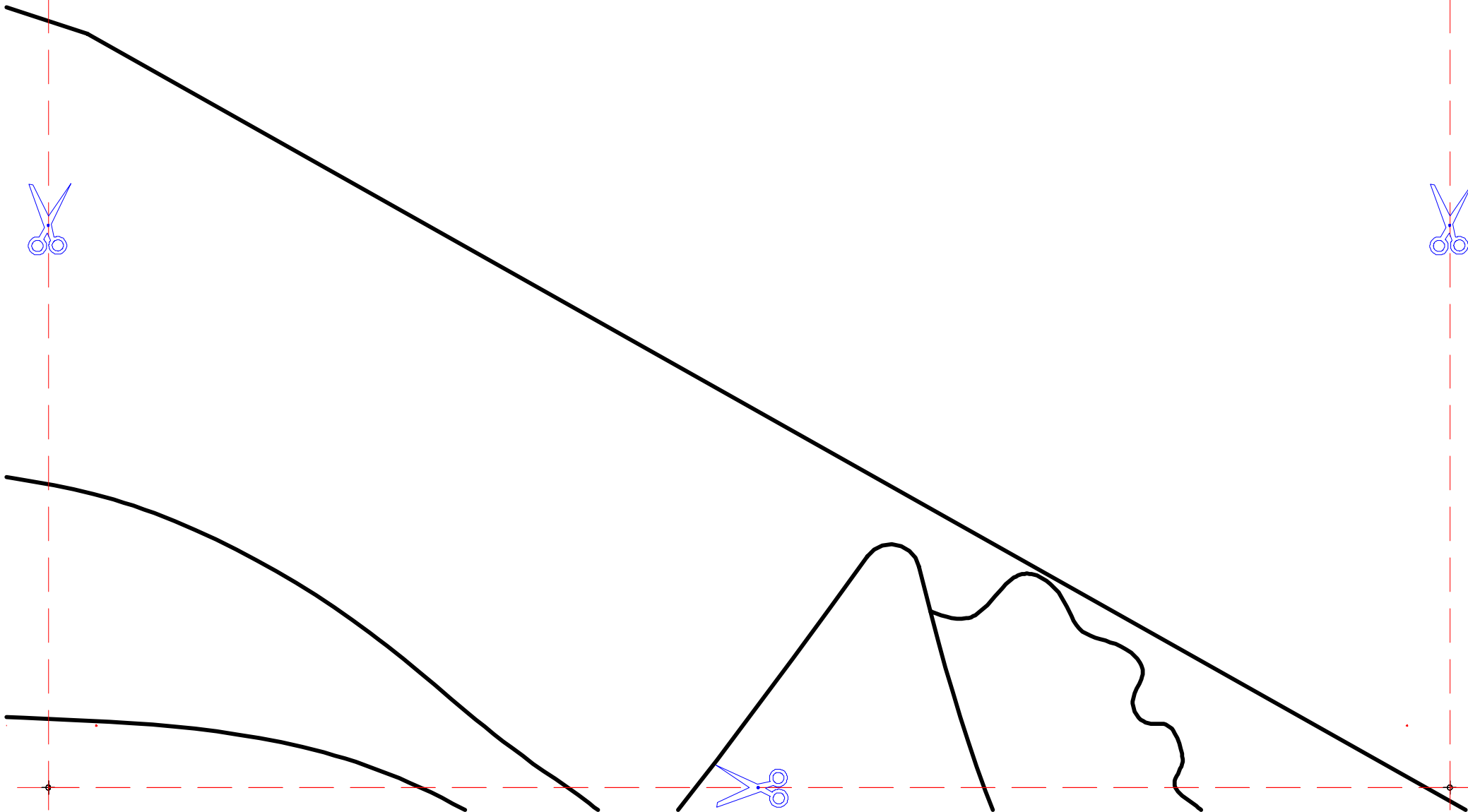
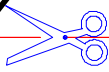
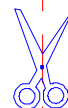
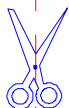
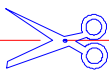

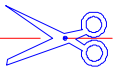

10

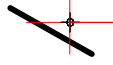
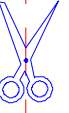
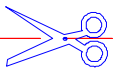

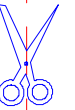
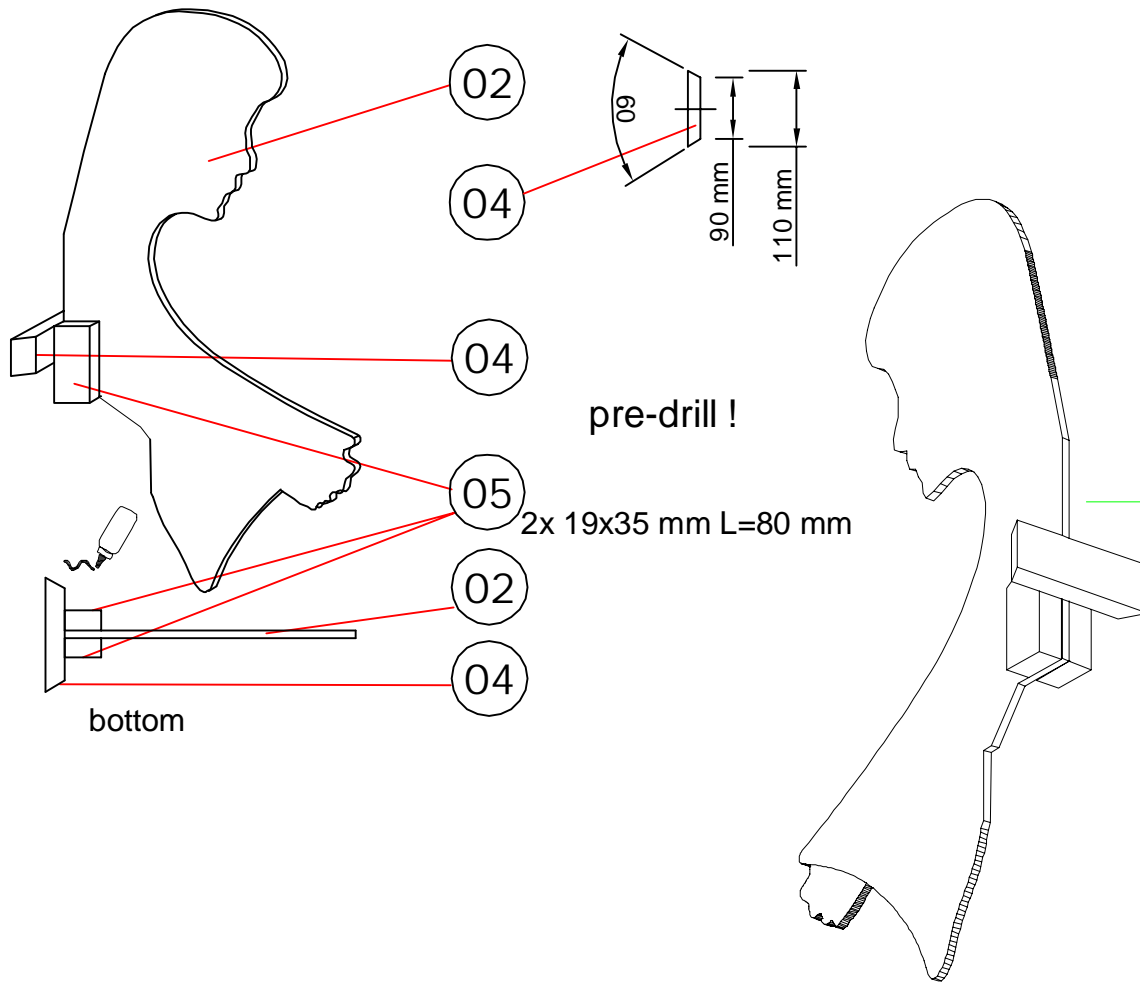
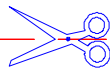

12

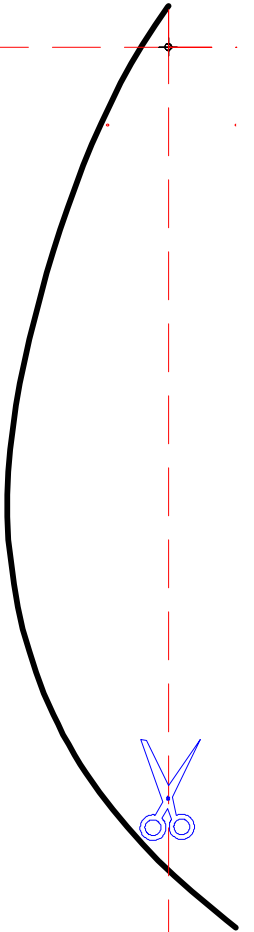
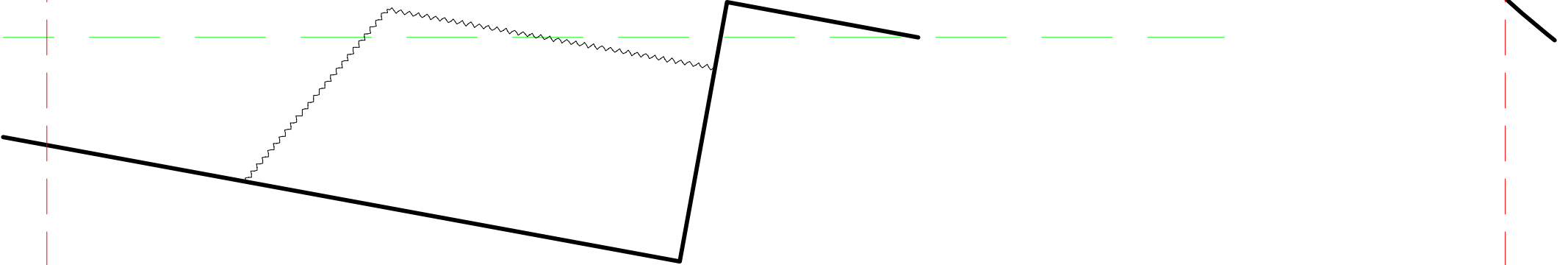
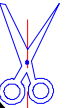
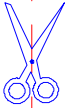
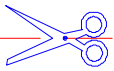

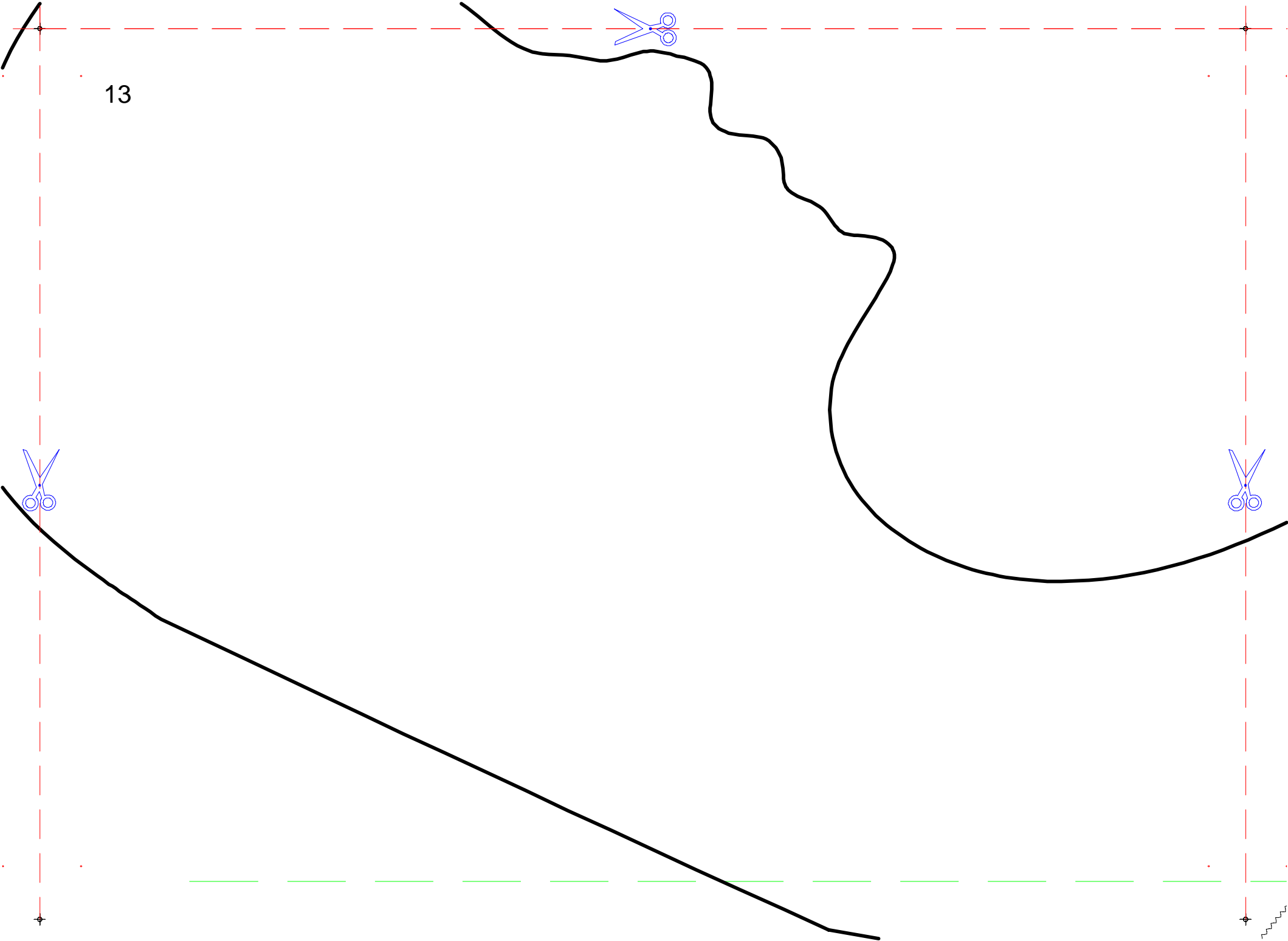

13

14

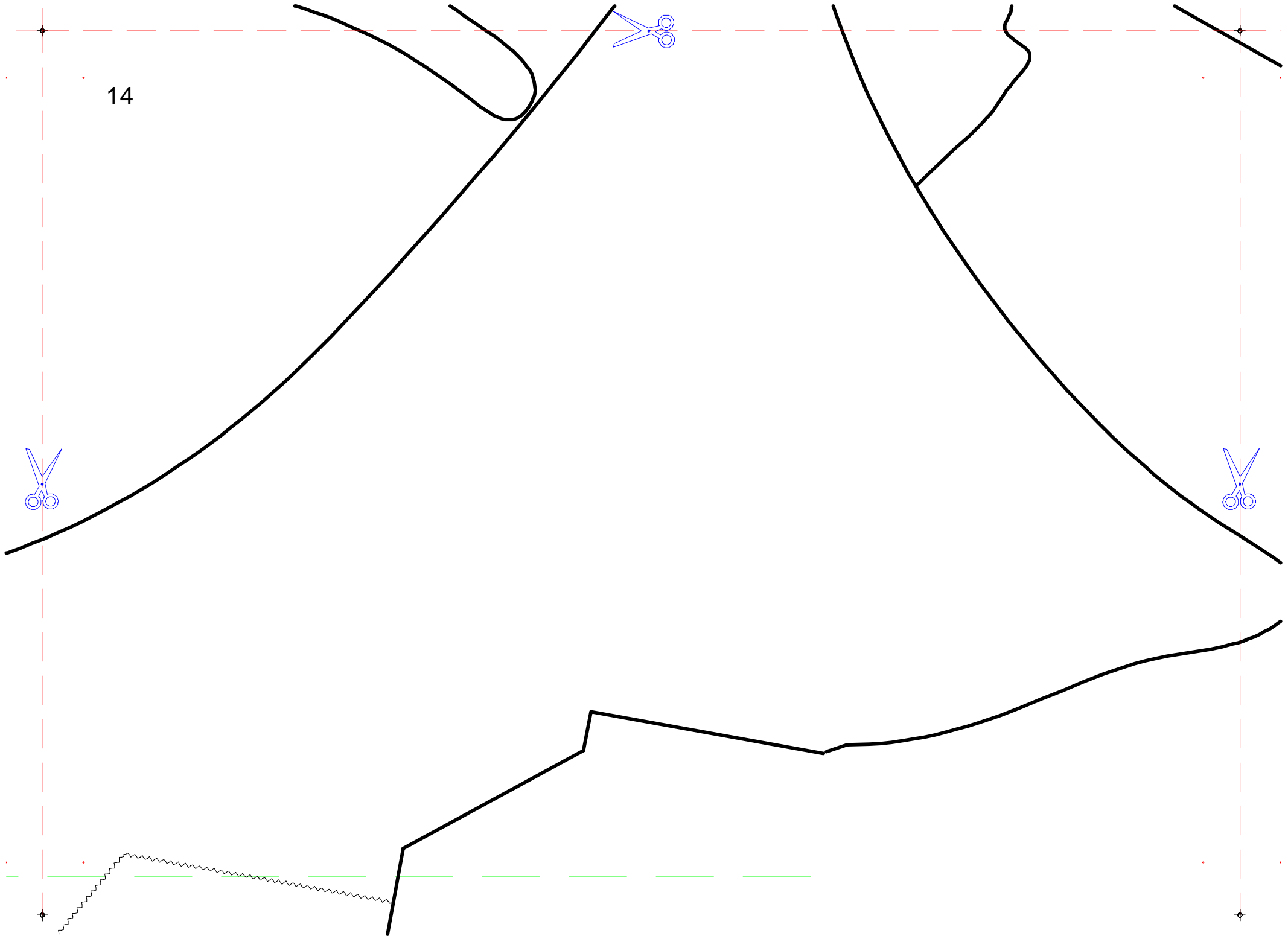

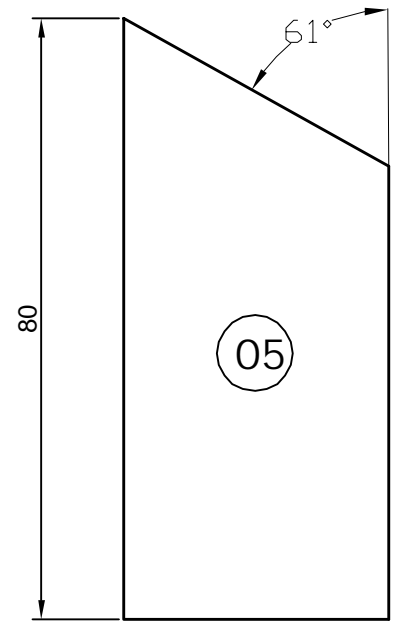
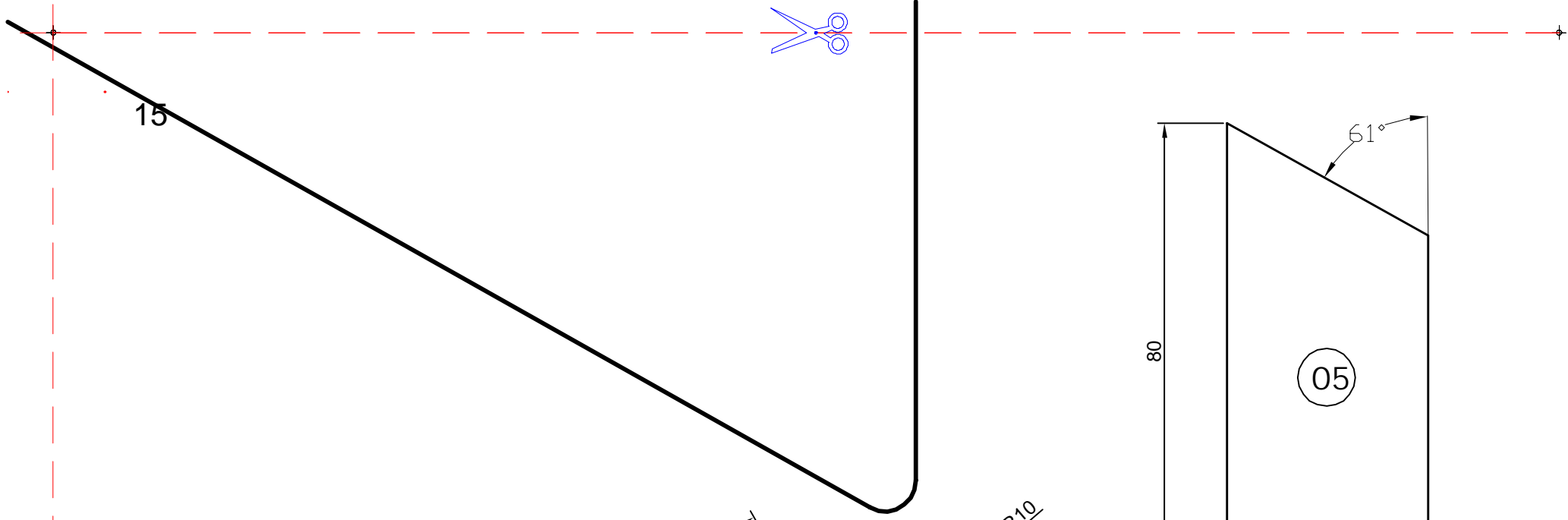

2x 19x35 mm L=80 mm

