

### Werkwijze

Knip het patroon uit. --- (buitenlijn)  
Tape de mal op het multiplex.  
Trek de omtrek over.  
Tekende boorgaten af.  
Verwijder de tape en het sjabloon.  
Boor de gaten (montage en scherpe bochten).  
Zaag het geheel uit (decoupeerzaag).  
Schuur alle oppervlakten.  
Schilder het geheel (grondverf).  
Knip de mal uit volgens de gestreepte lijnen uit. - - -  
Tekende lijnen aan beide zijden van het hout af.  
Schuur alles licht.  
Schilder het geheel (kleuren naar keuze).  
Monteer de steun met schroeven.

### Bauanleitung

Schneiden Sie das Muster aus. ---  
Kleben Sie die Schablone auf das Sperrholz.  
Übertragen Sie die Konturen.  
Markieren Sie die Bohrlöcher.  
Entfernen Sie das Klebeband und die Schablone.  
Bohrungen (Montage und scharfe Kurven).  
Sah die Umrisse mit einer Stichsäge.  
Schleifen aller Oberflächen.  
Grundiere das Ganze.  
Schneiden Sie die durch die gestrichelten Linien Vorlage. - - - -  
Zeichnen Sie die Linien auf beiden Seiten des Holzes entfernt.  
Dann nutzen Sie Schleifpapier.  
Malen (Farben Ihrer Wahl)  
Montieren Sie die Halterung mit Schrauben.

### Instructions

Cut out the pattern. --- (outline)  
Tape the template to the plywood.  
Draw round.  
Mark the drilling holes.  
Remove the tape and stencils.  
Drill holes (mounting and sharp bends).  
Saw the outline with a jigsaw.  
Sanding all surfaces.  
Paint the whole. (primer)  
Cut out the template by the dashed lines. - - - - -  
Draw the lines on both sides of the timber away.  
Then use sandpaper  
Paint the whole. (colours of your choice)  
Mount the bracket with screws.

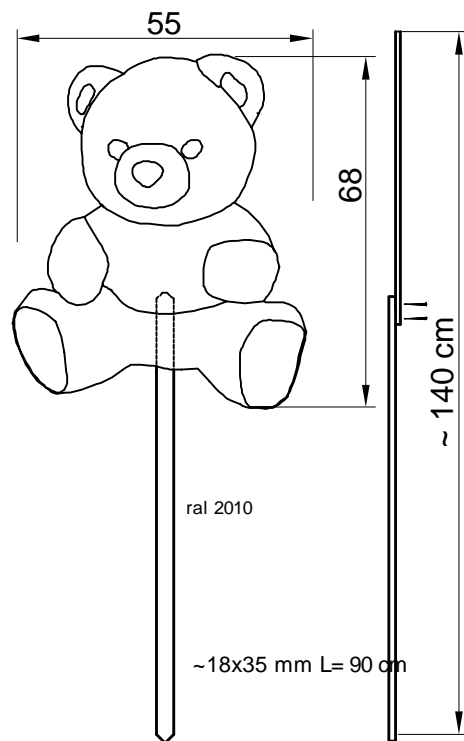

Geboorte bord  
Baby-Ankündigung  
Birth announcement sign

"BOLKE"

Size. ± 55x68 cm

#021

# ONZE PATRONEN SAMENSTELLEN ZUSEMMENSTELLEN UNSERER SCHNITTMUSTER ASSEMBLING OUR PATTERNS

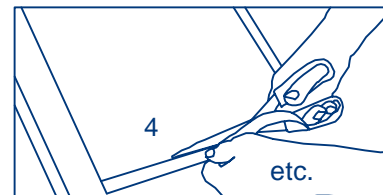
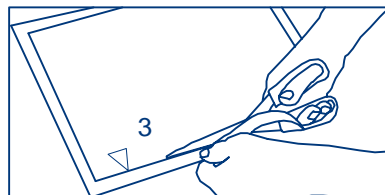
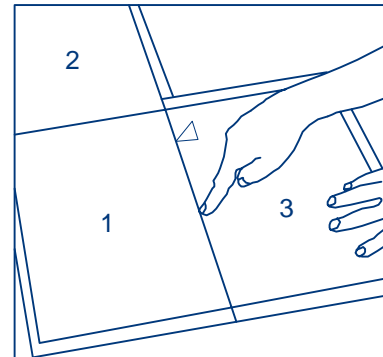
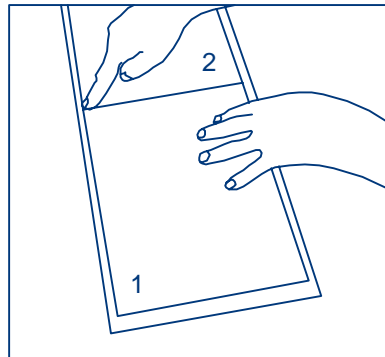
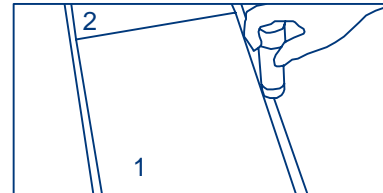
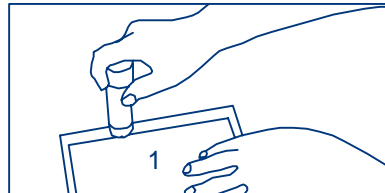
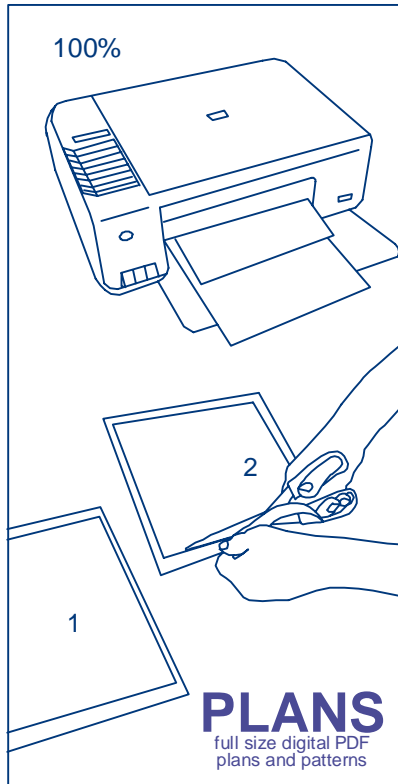

© plans Leeuwarden NL

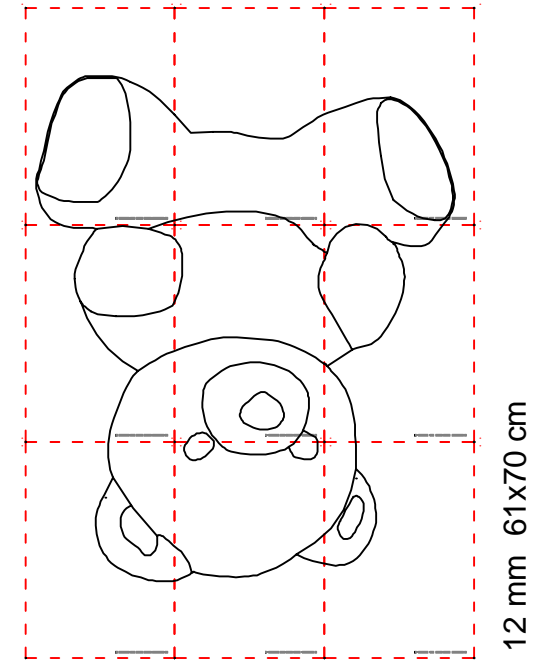

Het patroon monteren door de delen: \*Afdrukken op eigen printer op A4 100%. \*De linker en bovenrand volgens stippelijijn afknippen.

\*De rechterraand van nummer 1 met lijmstift insmeren en onder nummer 2 plakken tot de stippelijijn. enz

Montieren Sie das Muster durch die Teile: \*Druck auf eigenem Drucker auf A4 100%. \*Schneiden Sie die linke und obere Kante gemäß der gepunkteten Linie. \*Die rechte Kante von Nummer 1 mit einem Klebestift bestreichen und auf Nummer 2 kleben. etc.

Assemble the pattern through the parts: \*printing on own printer on A4 100%. \*cut the left and top edge according to the dotted line.

Coat the right edge of number 1 with a glue stick and stick to number 2. etc.

12 mm 61x70 cm

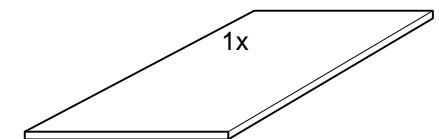

01

# Birth announcement sign "BOLKE"

Size~68x55 cm

#-021



© L.Lammertsma

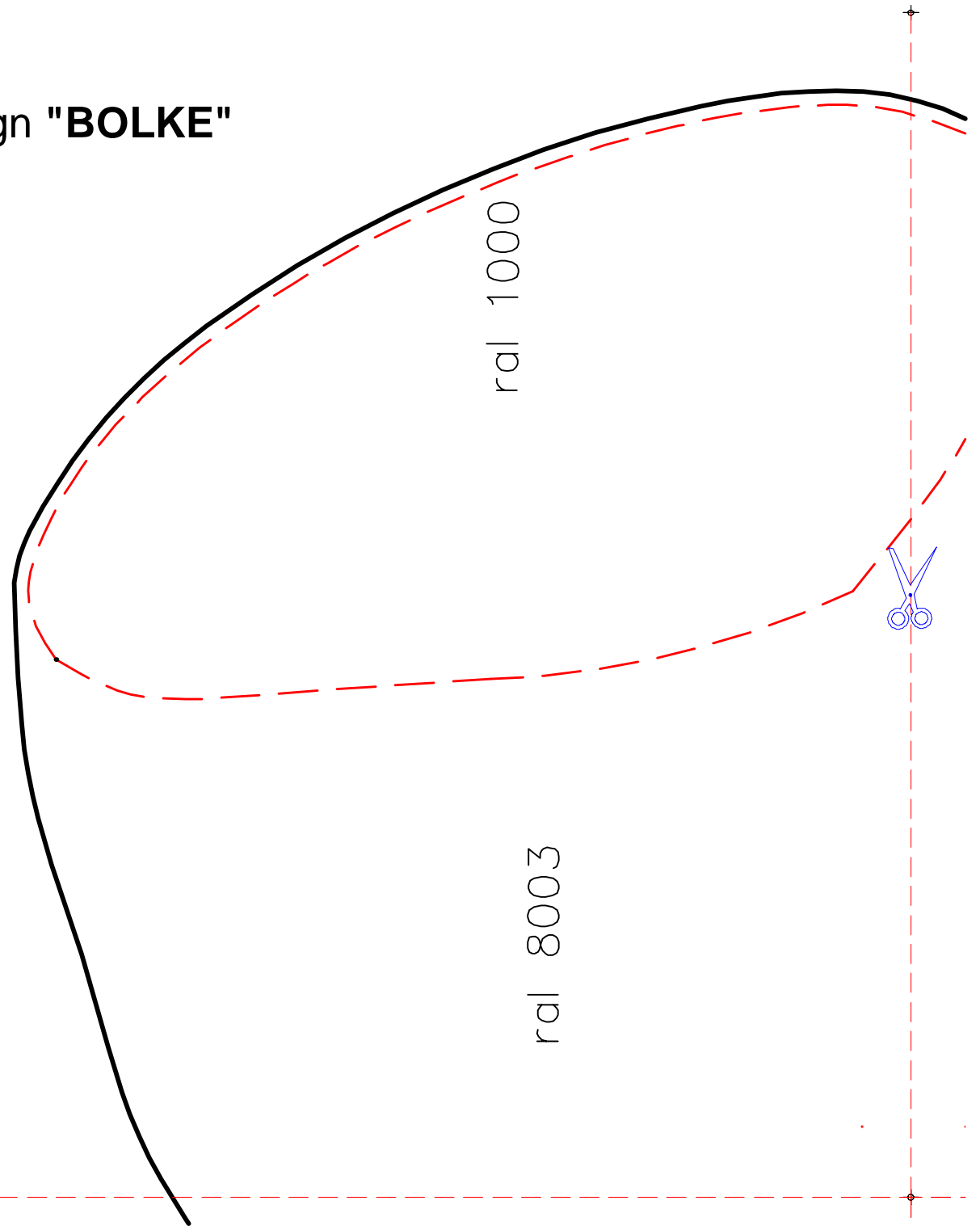

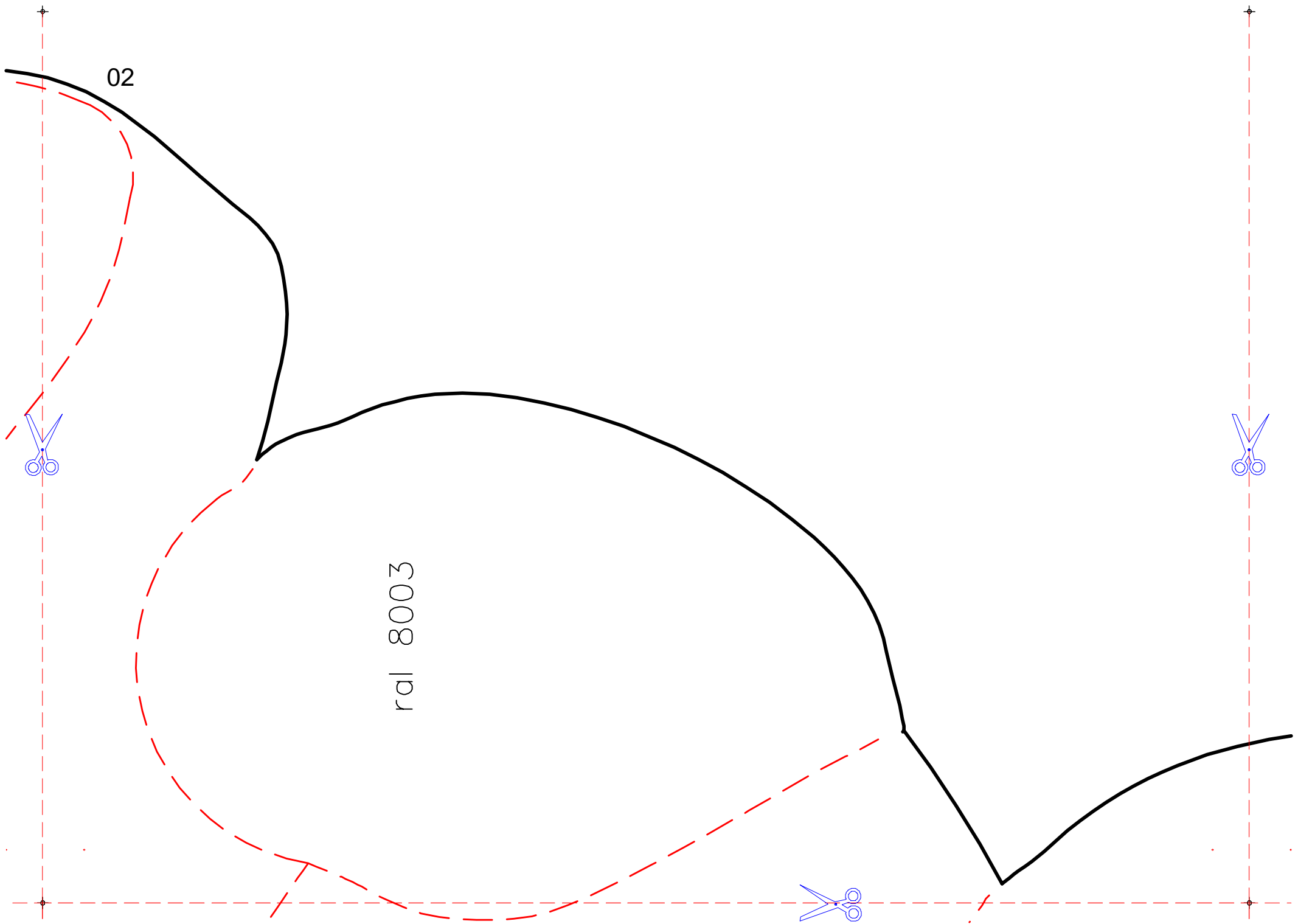

02

ral 8003

03

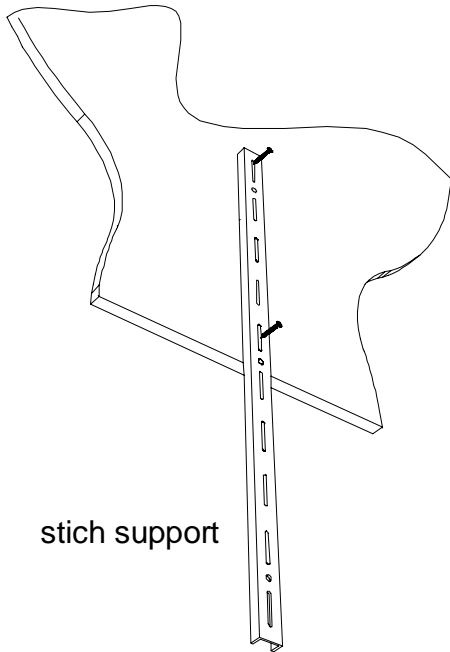

stich support

alternative ground support.

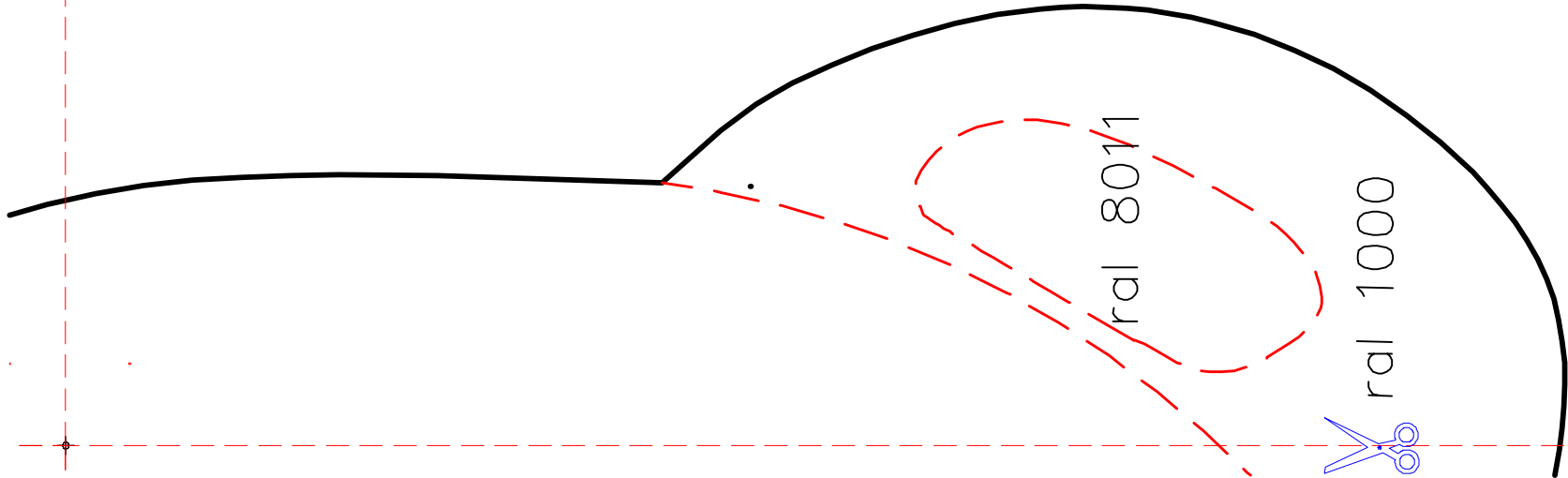
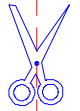

ral 8011

ral 1000

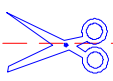

04

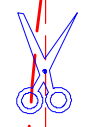
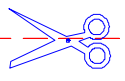

| 8003

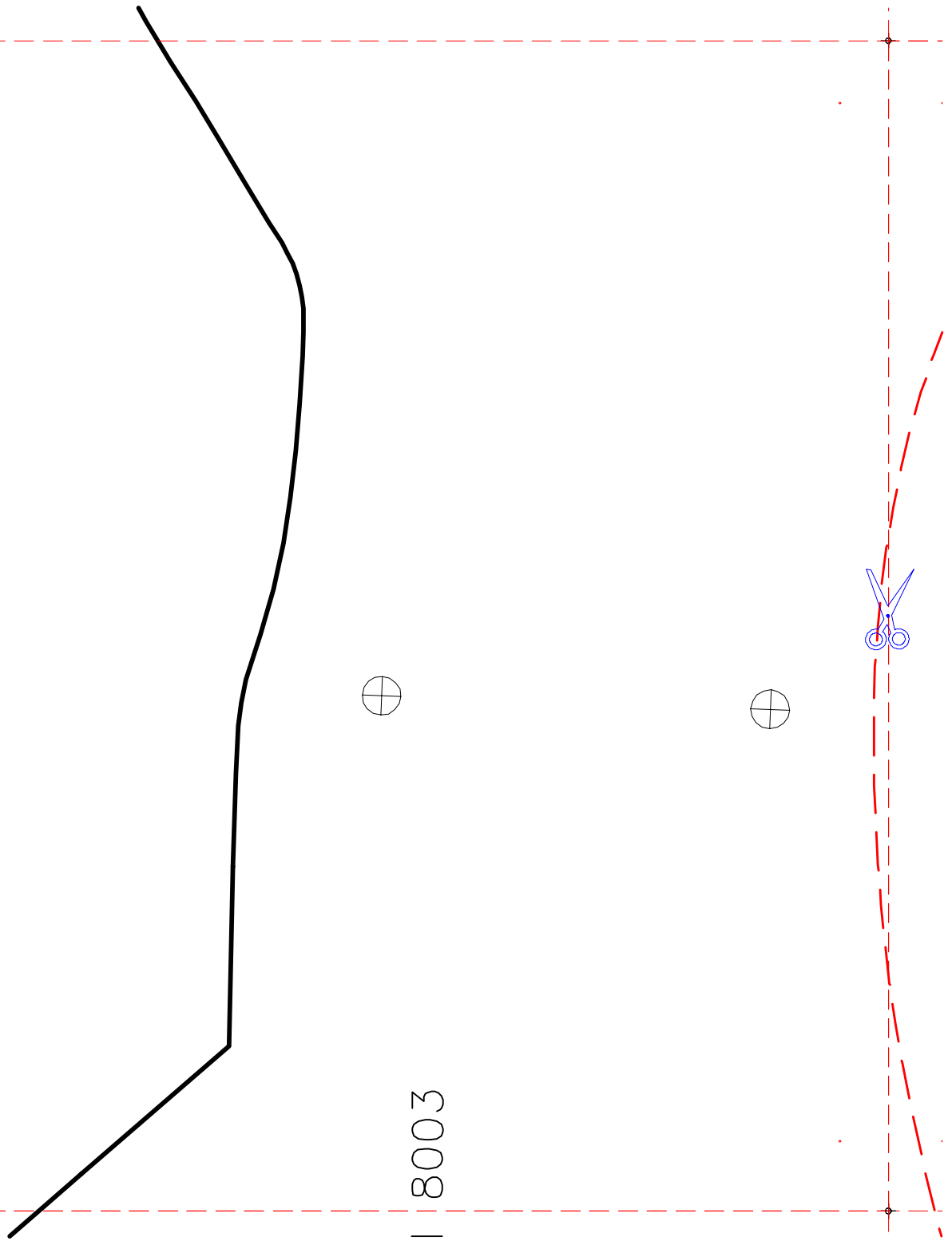

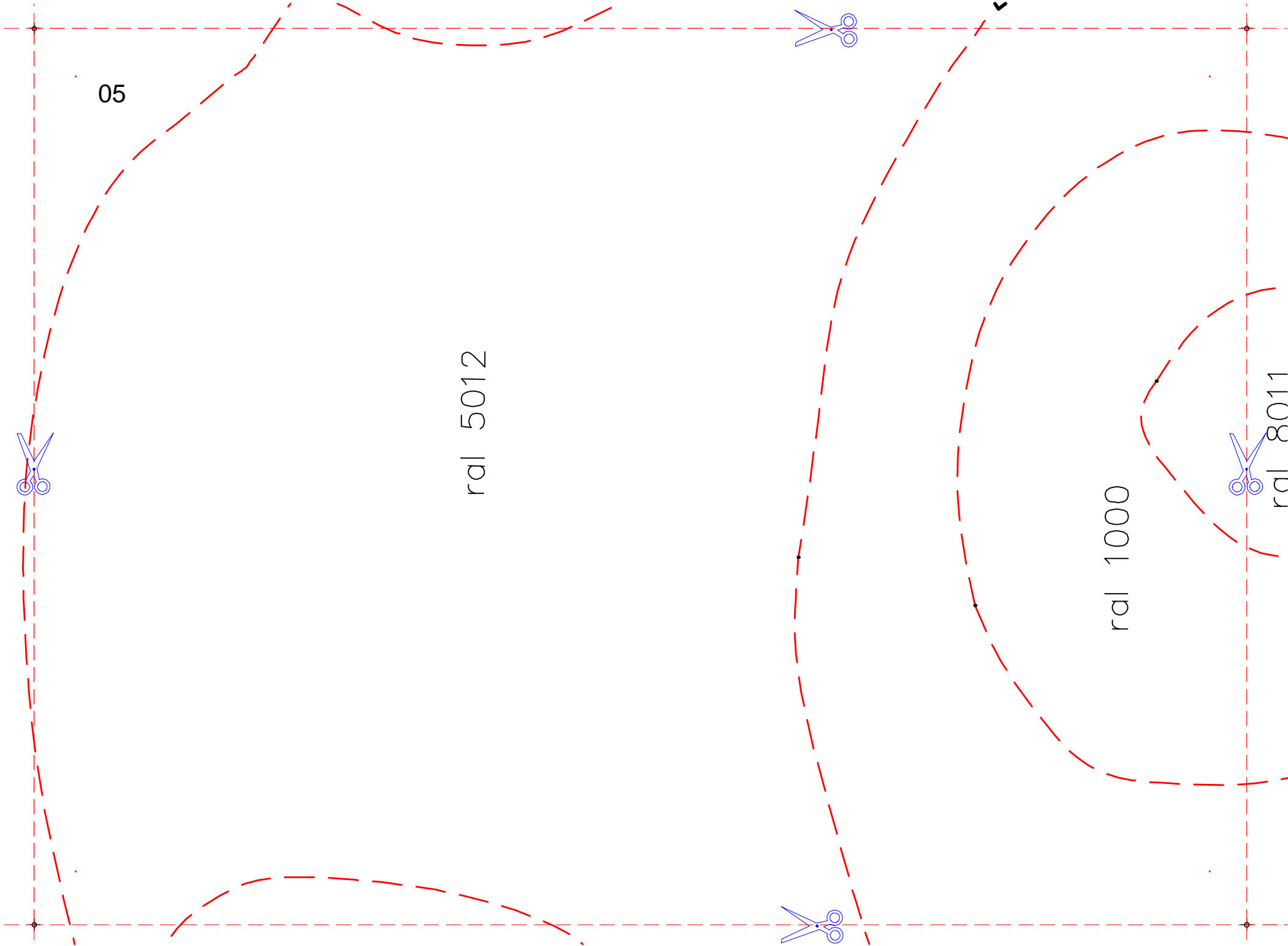

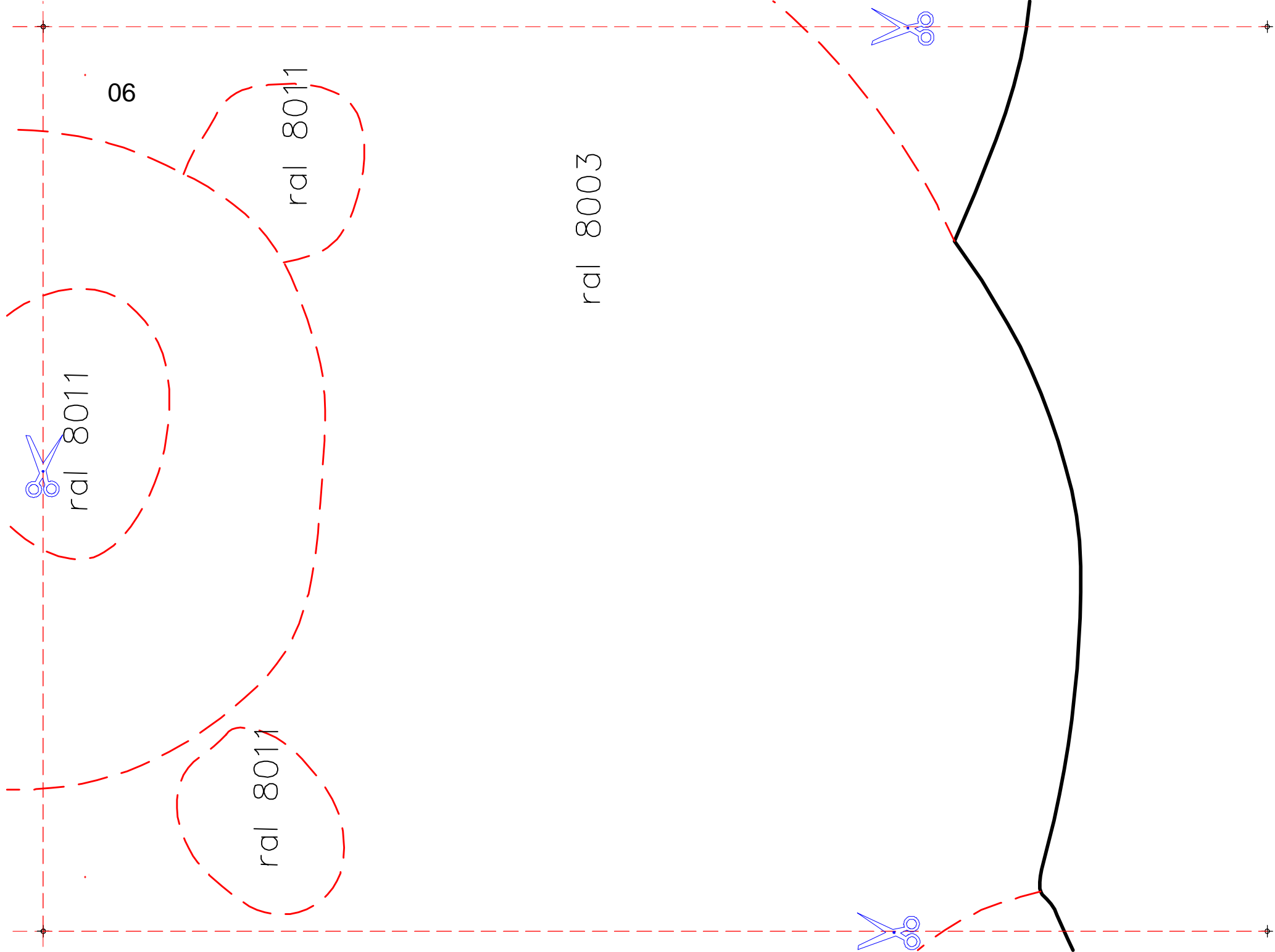



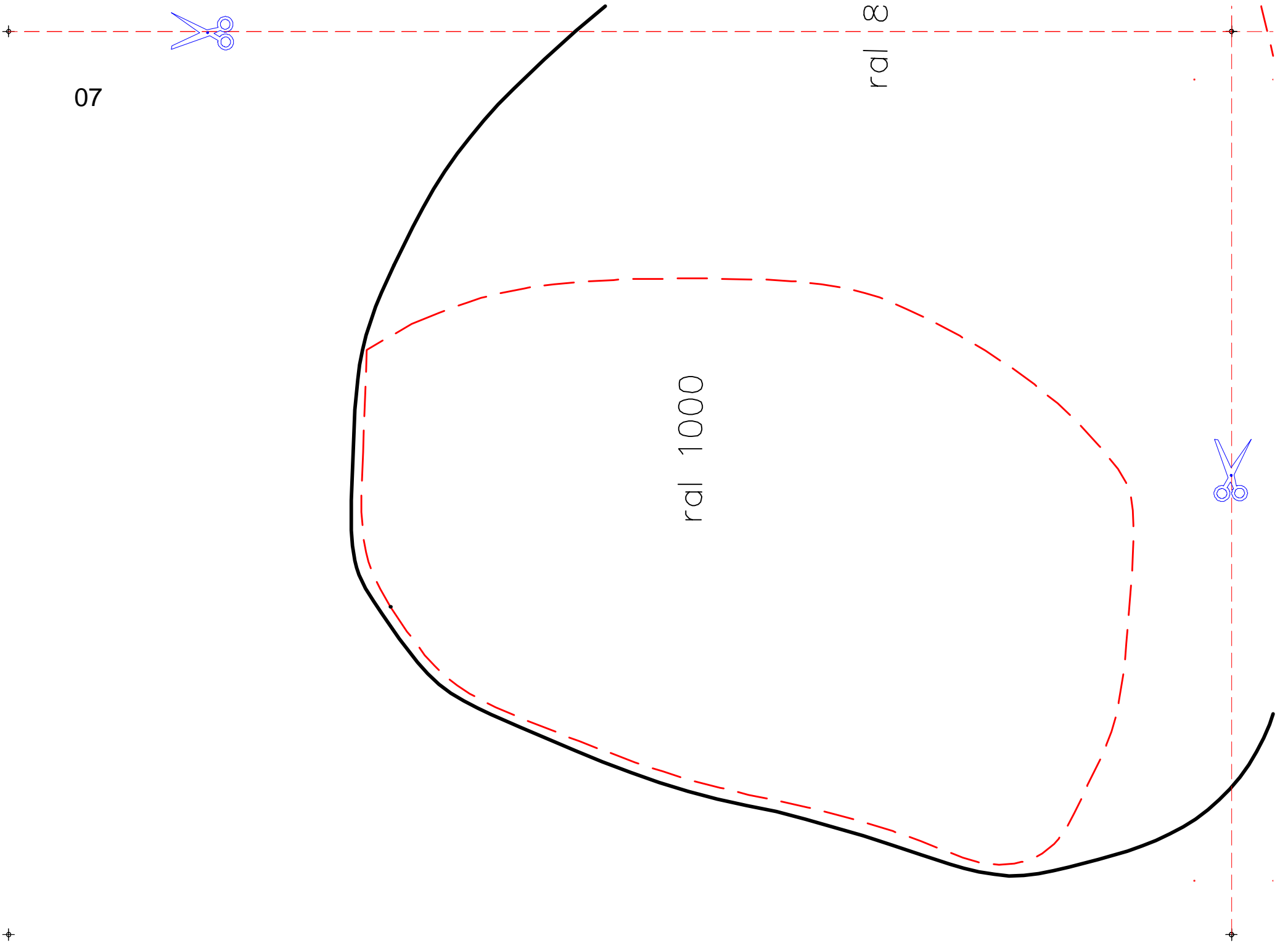

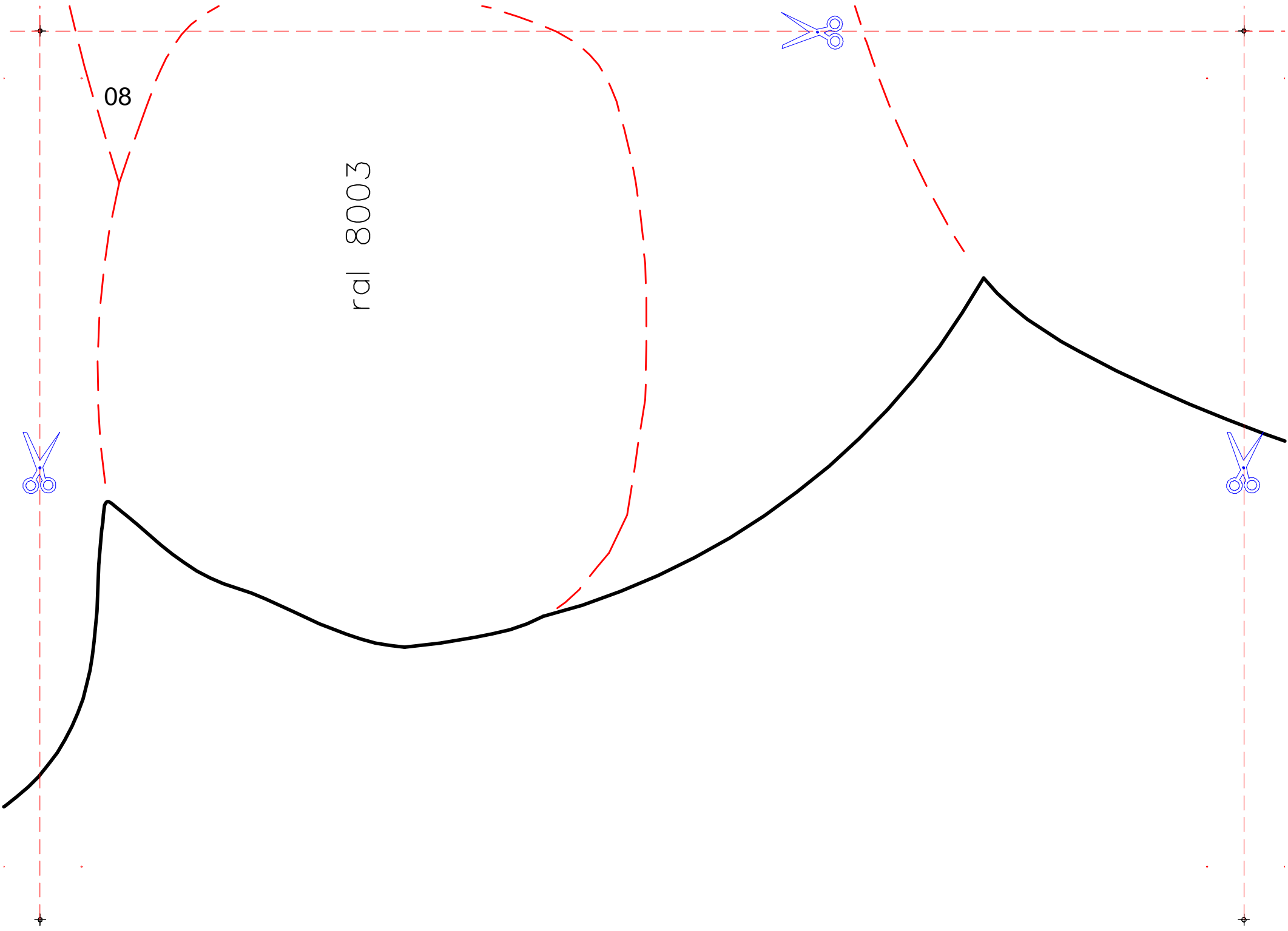

08

ral 8003

09

ral 1000

ral 8011

#-021

